

50 W Dimmable Freedom LED driver

Product code: 5816

50.4 W 220 – 240 V 0 / 50 – 60 Hz

- Future-proof Freedom Interface to power Freedom Node, enabling a various wireless lighting control systems support
- Hybrid Dimming technology for high quality light output.
- 1 - 100 % dimming range
- Very high efficiency up to 88 %
- Low current ripple
- Suitable for DC use
- Long lifetime up to 100 000 h
- Driver protection Class II
- Ideal solution for Class I and Class II
- For driving Class III (SELV) luminaires, optional strain relief available for independent use outside of luminaire (LC-SRB, LC-SRB-LOOP-2WIRE, LC1x70-SR)

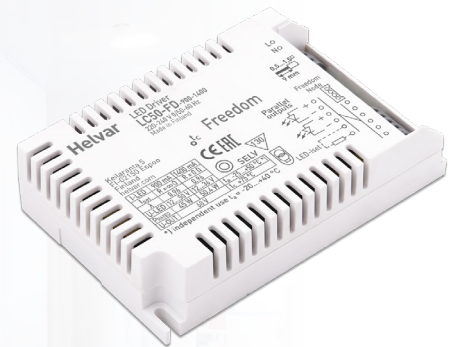

Freedom

Functional Description

- Adjustable constant current output: 900 mA (default) to 1400 mA.
- Current setting with external resistors.
- Hybrid Dimming technology for high quality light output.
- Full load recognition with automatic recovery and adaptive LED overload / open circuit / short circuit protection.
- Inbuilt power supply for external Freedom Node / luminaire intelligent unit use.
- Extensive smart data availability through Freedom Interface, including e.g power consumption monitoring.
- Helvar Freedom Interface 1.5 support.

Mains Characteristics

Nominal rated voltage range	220 V – 240 V, 0 / 50 – 60 Hz
AC voltage range	198 VAC – 264 VAC
	Withstands max. 320 VAC (max. 1 hour)
	Withstands min. 176 VAC (max. 1 hour)
DC voltage range	176 VDC – 280 VDC
DC starting voltage	> 190 VDC
Mains current at full load	0.22 – 0.31 A
Frequency	0 / 50 Hz – 60 Hz
Stand-by power consumption	< 0.5 W
THD at full power	< 15 %
Tested surge protection	1 kV L-N, 2 kV L-GND (IEC 61000-4-5)
Tested fast transient protection	4 kV (IEC 61000-4-4)

Insulation between circuits & driver case

Mains circuit - SELV output circuit	Double/reinforced insulation
Mains and output - Driver case	Double/reinforced insulation

Load Output (non-isolated)

Output current (I_{out})	900 mA (default) – 1400 mA
Accuracy	± 5 %
Ripple	< 2 %* at ≤ 120 Hz
	*] Low frequency, LED load: Cree MX3 LEDs
U_{out} (max) (abnormal)	60 V

I_{LED}	900 mA	1400 mA
P_{Rated}	45 W	50.4 W
U_{LED}	12 – 50 V	12 – 36 V
PF (λ) at full load	0.96	0.96
Efficiency (η) at full load	88 %	87 %

Operating window

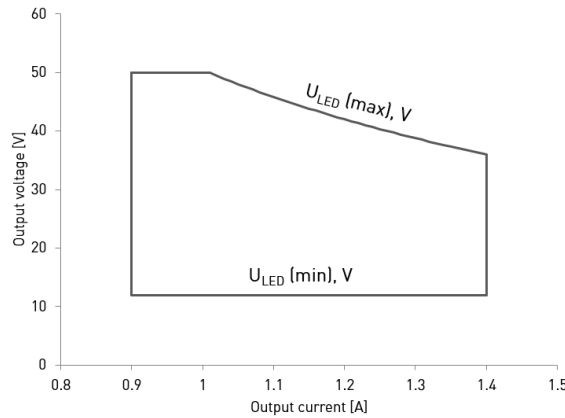

Note: Dimming between 1% - 100% possible across the whole operating window

Driver performance

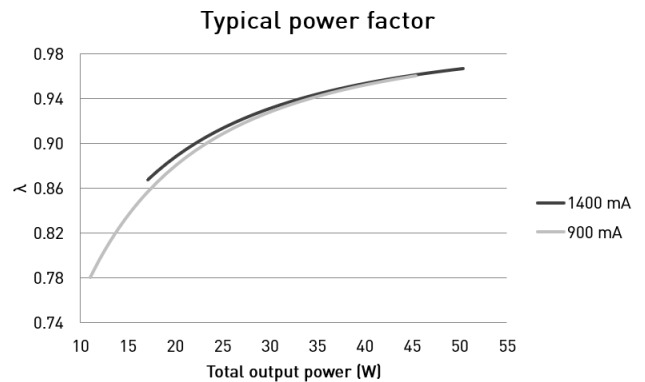
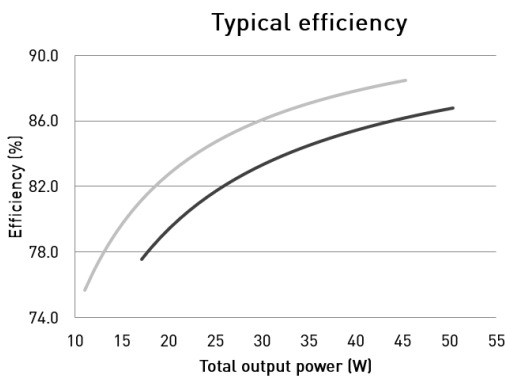

Operating Conditions and Characteristics

Absolute highest allowed t_c point temperature	75 °C
T_c life (50 000 h) temperature	75 °C
Ambient temperature range	-25 °C .. +50 °C*
Storage temperature range	-40 °C .. +80 °C
Maximum relative humidity	No condensation
Life time (90 % survival rate)	100 000 h, at $t_c = 65$ °C 70 000 h, at $t_c = 70$ °C 50 000 h, at $t_c = 75$ °C

*) For other than independent use, higher t_s of the controlgear possible as long as highest allowed t_c point temperature is not exceeded

Quantity of drivers per miniature circuit breaker 16 A Type C

Based on inrush current I_{peak}	Typ. peak inrush current I_{peak}	1/2 value time, Δt	Calculated energy, $I_{peak}^2 \Delta t$
61 pcs	29 A	146 μs	0.097 A ² s

CONVERSION TABLE FOR OTHER TYPES OF MINIATURE CIRCUIT BREAKER

MCB type	Relative quantity of LED drivers
B 10 A	37 %
B 16 A	60 %
B 20 A	75 %
C 10 A	62 %
C 16 A	100 % (see table above)
C 20 A	125 %

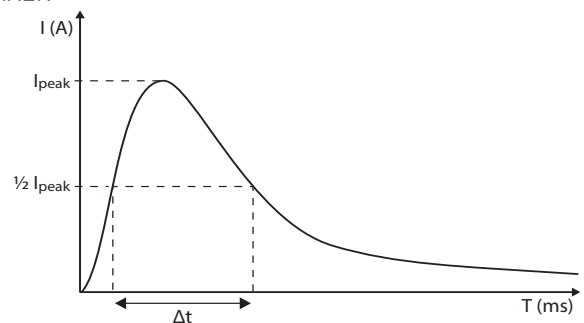

CONTINUOUS CURRENT

Total continuous current of the drivers and installation environment must always be considered and taken into calculations when installing drivers behind miniature circuit breaker. Example calculation of total drivers amount limited by continuous current: $n(I_{cont}) = [16 A (I_{nom, Ta}) / \text{"nominal mains current with full load"}] \times 0.76$. This calculation is an example according to recommended precautions due to multiple adjacent circuit breakers (> 9 MCBs) and installation environment (T_a 30 degrees); variables may vary according to the use case. Both inrush current and continuous current calculations are based on ABB S200 series circuit breakers. More specific information in ABB series S200 circuit breaker documentation.

NOTE! Type C MCB's are strongly recommended to use with LED lighting. Please see more details in "MCB information" document in each driver product page in "downloads & links" section.

Enhanced Hybrid dimming technique

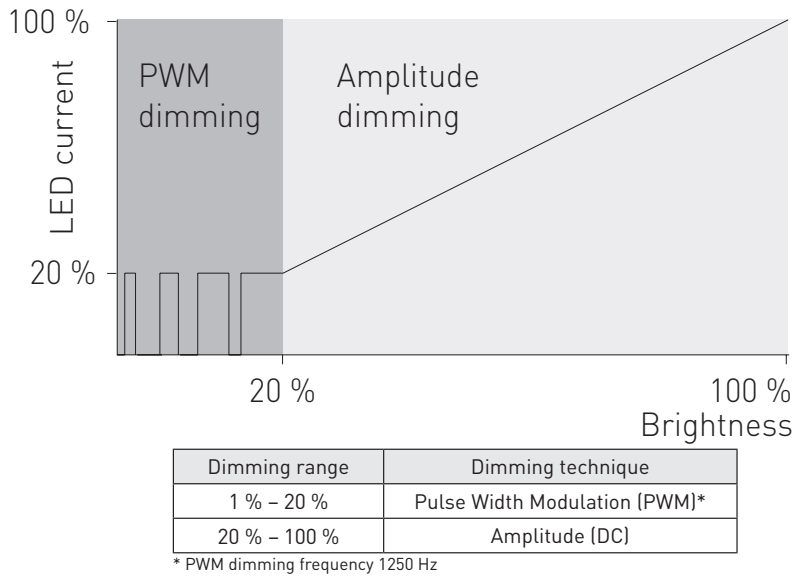

Helvar hybrid dimming products combine the best features from Amplitude dimming and from Pulse Width Modulation (PWM) dimming. CCR is a very efficient technique for dimming the light output especially on higher range. On lower range, the hybrid dimming products implement high-frequency PWM dimming to ensure high quality dimming from 20 % down to 1 % providing low flicker dimming performance.

Freedom power output as external “luminaire intelligence unit” supply

Helvar Freedom drivers supports external control unit usage with the Freedom Node - power output. The driver can use the Freedom Node - output terminal to supply power and connect with Freedom Node - intelligent communication units via UART digital communication. The power supply specification and pin order for connector are listed in the details below. For further SW side integration, please contact Helvar.

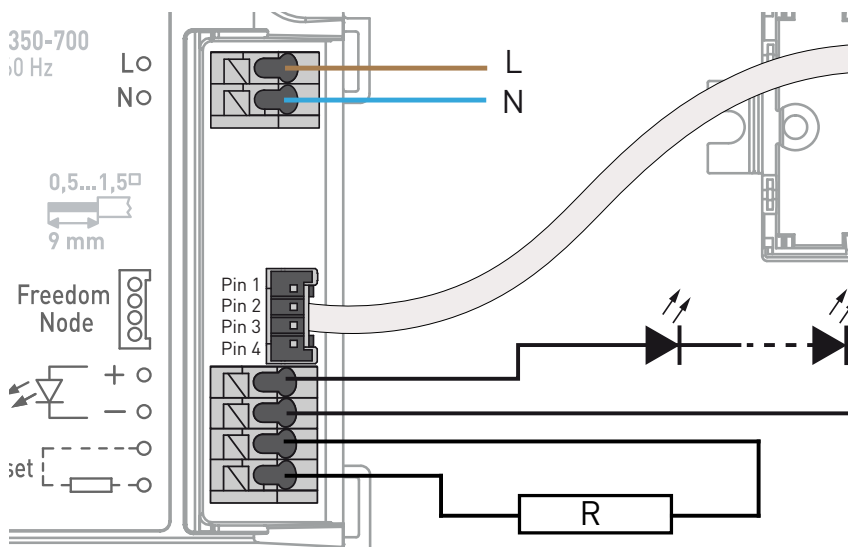

Pin connections

- Pin 1 Rx (Digital signal)*
- Pin 2 Ground
- Pin 3 VDD
- Pin 4 Tx (Digital signal)*

* Rx/Tx From LED driver perspective.

Power supply specification

- Voltage 3.3 V (±0.3 V)*
- Continuous current max. 16 mA
- Peak current 30 mA (max. 100 ms each 5 Hz cycle)
- Standby mode current max. 10 mA**
- Connector MOLEX (35363-0460)

* Not continuous voltage supply by default.

** (Networked) standby power < 0,5 W

The UART communication follows Helvar Freedom Interface 1.5 by default. For more details about the communication protocol, please contact Helvar.

Connections and Mechanical Data

Wire size	0.5 mm ² – 1.5 mm ²
Wire type	Solid core and fine-stranded
Wire insulation	According to EN 60598
Maximum driver to LED wire length	1.5 m
Weight	172 g
IP rating	IP20

Connections

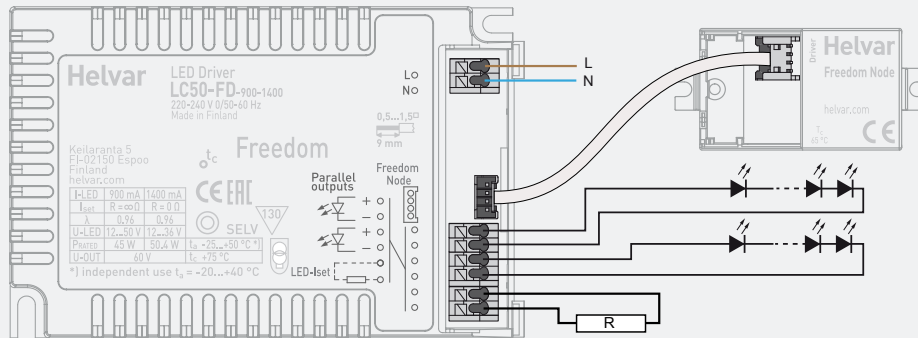

Note:

- Label may differ if the unit is preset to fixed current
- Not suitable for load side switching operation

Dimensions (mm)

With strain relief (LC1x70-SR)

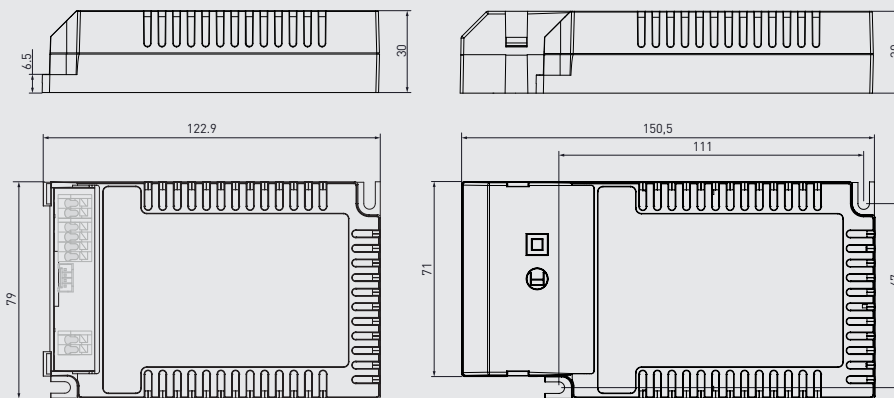

The current setting values are adjusted according to the LEDset specification. The resistor value for each required output current can thus be calculated from the formula $R [\Omega] = (5 [V] / I_{out} [A]) * 1000$. Below are the available LED-Iset resistors from Helvar, pre-adjusted for the most common output currents.

Helvar LED-Iset resistors and currents (Nominal I_{out} ($\pm 5\%$ tol.))

LED-Iset resistor model	MAX	1350 mA	1300 mA	1250 mA	1200 mA	1150 mA	1100 mA	1050 mA	1000 mA	950 mA	No resistor
I_{out} (mA)	1400	1350	1300	1250	1200	1150	1100	1050	1000	950	900
Order code	T90000	T91350	T91300	T91250	T91200	T91150	T91100	T91050	T91000	T90950	N/A
Resistance values (Ω)	0	3.74k	3.83k	4.02k	4.12k	4.32k	4.53k	4.75k	4.99k	5.23k	∞

The current can be adjusted also with normal resistors by selecting suitable resistor value (formula $R [\Omega] = (5 [V] / I_{out} [A]) * 1000$). Reference resistor values can be found below order code in the table above.

LC50-FD-900-1400 LED driver is suited for built-in usage in luminaires. With strain reliefs, independent use is possible too (see the strain-relief datasheets for details). In order to have safe and reliable LED driver operation, the LED luminaires will need to comply with the relevant standards and regulations (e.g. IEC/EN 60598-1). The LED luminaire shall be designed to adequately protect the LED driver from dust, moisture and pollution. The luminaire manufacturer is responsible for the correct choice and installation of the LED drivers according to the application and product datasheets. Operating conditions of the LED drivers may never exceed the specifications as per the product datasheet.

Installation & operation

Maximum ambient and t_c temperature

- For built-in components inside luminaires, the t_a ambient temperature range is a guideline given for the optimum operating environment. However, integrator must always ensure proper thermal management (i.e. mounting base of the driver, air flow etc.) so that the t_c point temperature does not exceed the t_c maximum limit in any circumstance.
- Reliable operation and lifetime is only guaranteed if the maximum t_c point temperature is not exceeded under the conditions of use.

Current setting resistor

LC50-FD-900-1400 LED driver features a constant current output adjustable via current setting resistor.

- An external resistor can be inserted in to the current setting terminal, allowing the user to adjust the LED driver output current
- When no external resistor is connected, then the LED drivers will operate at their default lowest current level
- A standard through-hole resistor can be used for the current setting. To achieve the most accurate output current it is recommended to select a quality low tolerance resistor. Minimum diameter for resistor leg is 0.51mm.
- Always connect the current setting resistor only into the terminals marked with Iset on the LED driver label.
- For the resistor/current value selection, refer to the table on page 4.

Installation site:

- The general preferred installation position of LED drivers for independent use is to have the top cover facing upwards.

Miniature Circuit Breakers (MCB)

- Type-C MCB's with trip characteristics in according to EN 60898 are recommended.
- Please see more details in "MCB information" document in each driver product page in "downloads & links" section.

Lamp failure functionality

No load: When open load is detected, driver will go to standby. Automatic recovery is on during the first 10 minutes. If open load is still detected after the first 10 minutes, driver goes to standby mode and recovers through mains reset.

Overload: The driver can withstand overload. When small overvoltage occurs, the driver adaptively lower the output current to adjust the output power. When high overload occurs, the driver goes to standby.

Underload: The driver can withstand underload. When underload occurs, the driver goes to standby.

Short circuit: The driver can withstand output short circuit. When short circuit occurs, the driver goes to standby.

Conformity & standards

General and safety requirements	EN 61347-1: 2015
Particular safety requirements for DC or AC supplied electronic control gear for LED modules	EN 61347-2-13: 2014+ A1:2017
Thermal protection class	EN 61347, C5e
Mains current harmonics	EN 61000-3-2: 2014
Limits for voltage fluctuations and flicker	EN 61000-3-3: 2013
Radio frequency interference	EN 55015: 2013+ A1: 2015
Immunity standard	EN 61547: 2009
Performance requirements	EN 62384: 2006+ A1:2009
Compliant with relevant EU directives	
RoHS / REACH compliant	
CE marked	

Label symbols



Safety isolating control gear with short circuit protection (SELV control gear).



Double insulated control gear suitable for built-in use.



Thermally controlled control gear, incorporating means of protection against overheating to prevent the case temperature under any conditions of use from exceeding 110 °C.

Freedom A control gear supporting a wireless luminaire control solutions via Freedom Interface.